

GXO-5300G

5032 Tight stability / high freq

OSC

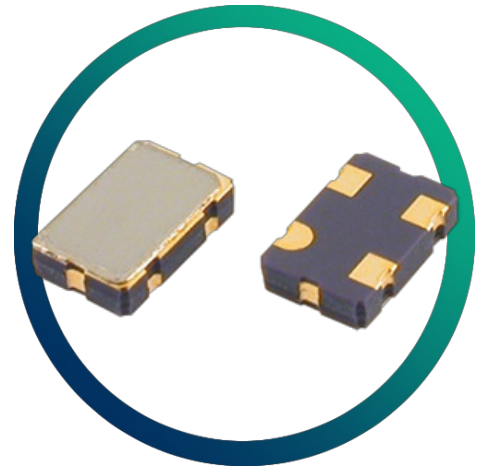

- High precision with tight stability options
- Wide operating temperature ranges
- High frequency fundamental - no multiplier
- Low & medium volumes also available
- Enable / disable tristate function

CONFIGURABLE OPTIONS

Parameter	Option Code
-----------	-------------

PACKAGE DRAWING

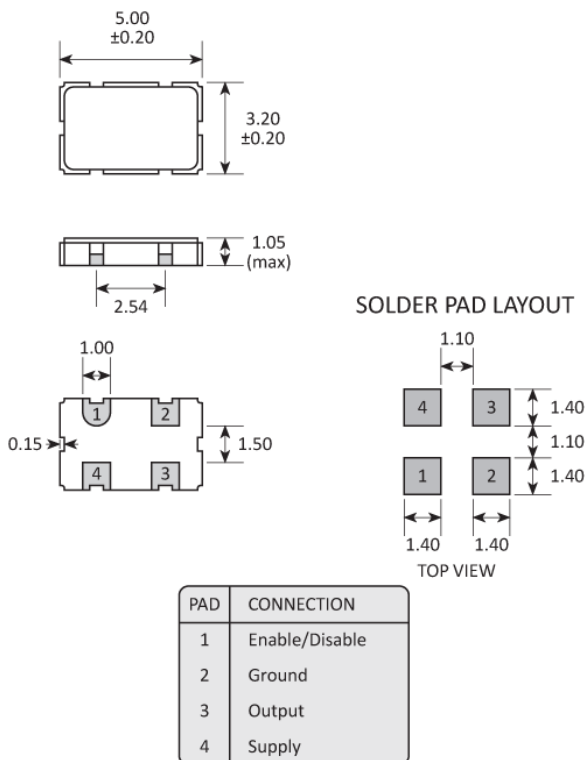

Dimensions in mm

ORDERING INFORMATION

To request a quotation for the GXO-5300 please use the configurable options form to choose the options you require and then submit your configured product to our team. Our expert advisers are always happy to help with your requirements and can be contacted on +44 1460 256 100 or at sales@golledge.com.

Following product selection you will be issued with a seven character Golledge part number. Your Golledge part number is the internationally accepted Golledge manufacturing part number (MPN) that should be used for all project documentation, including bills of materials (BoMs) and purchase orders.

If you have any queries regarding any of our documentation our dedicated sales team will be happy to help.

ENABLE / DISABLE FUNCTION

Input (pad 1)	Output (pad 3)
Open	Enabled
'1' level	Enabled
'0' level	High Impedance

MARKING

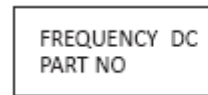

DC = Date Code in YM, eg. "GF" = Jun 2017

	A	B	C	D	E	F	G	H	J	K	L	M
Y	1	2	3	4	5	6	7	8	9	0		
M	Jan	Feb	Mar	Apr	May	Jun	Jul	Aug	Sep	Oct	Nov	Dec

SOLDERING PROFILE

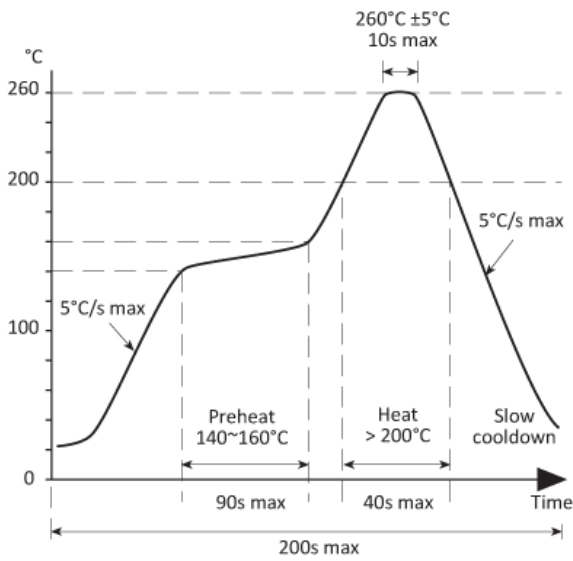

TAPE & REEL SPECIFICATION

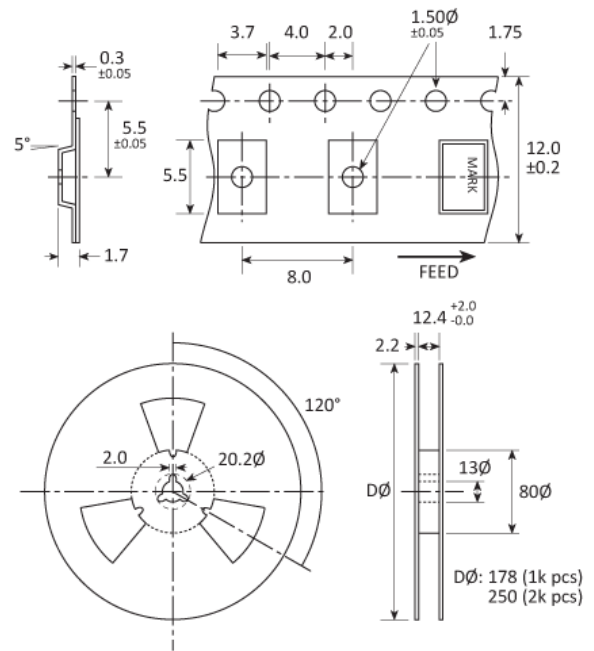

Dimensions in mm

HANDLING & STORAGE



Human Body Model (HBM) 1A (250V to < 500V)





Moisture Sensitivity Level (MSL): 1

CONSTRUCTION

Ceramic body with gold-plated pads Metal lid, seam sealed

COMPLIANCE

 Lead-free (< 0.1% by weight)

 RoHS compliant with no exemptions.