

SAW Filter 1590MHz

Model: TA0638A

Part No: MA09581

REV. NO.: 1

A. MAXIMUM RATING:

1. Input Power Level: 10 dBm
2. DC Voltage : 3V
3. Operating Temperature: -55°C to +85°C
4. Storage Temperature: -55°C to +95°C

B. ELECTRICAL CHARACTERISTICS:

Item		Unit	Min.	Type.	Max.	Note
Center Frequency	Fc	MHz	-	1590	-	-
Min. Insertion Loss	IL	dB	-	2.3	4	-
Amplitude ripple		dB	-	1	1.8	-
Bandwidth @ -1dB		MHz	55	59	65	-
Bandwidth @ -20dB		MHz	-	97	125	-
Ultimate rejection		dB	-	50	-	-

C. MEASUREMENT CIRCUIT:

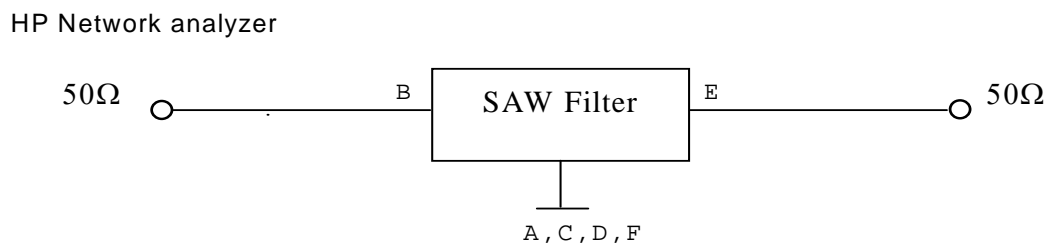

SAW Filter 1590MHz

Model: TA0638A

Part No: MA09581

REV. NO.: 1

D. OUTLINE DRAWING:

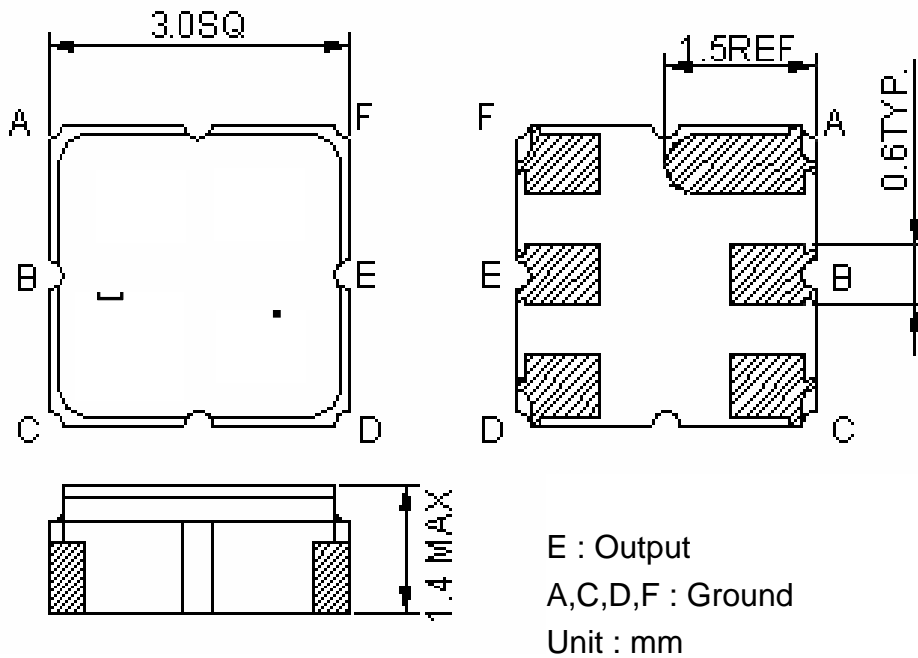

E. PCB FOOTPRINT:

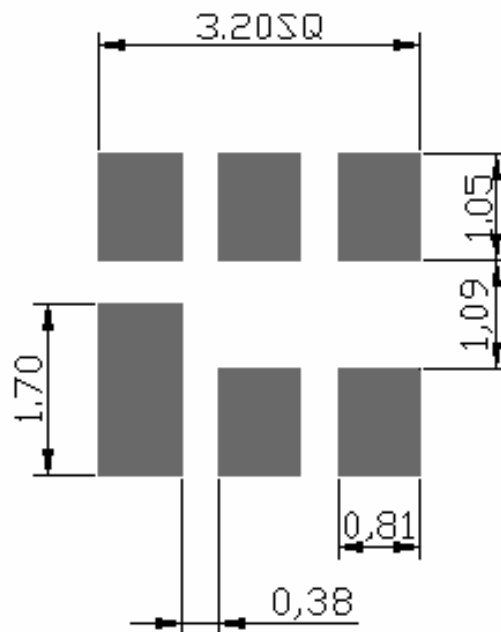

SAW Filter 1590MHz
Part No: MA09581

Model: TA0638A
REV. NO.: 1

F. FREQUENCY CHARACTERISTICS:

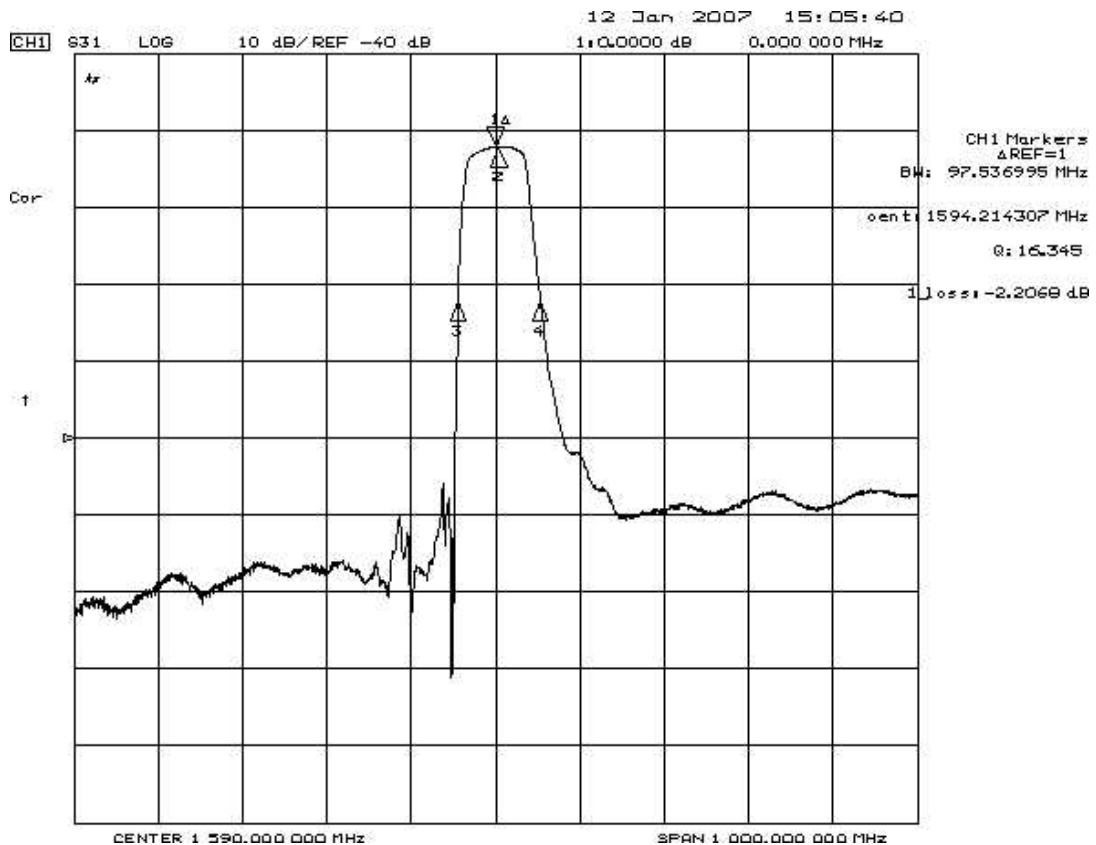
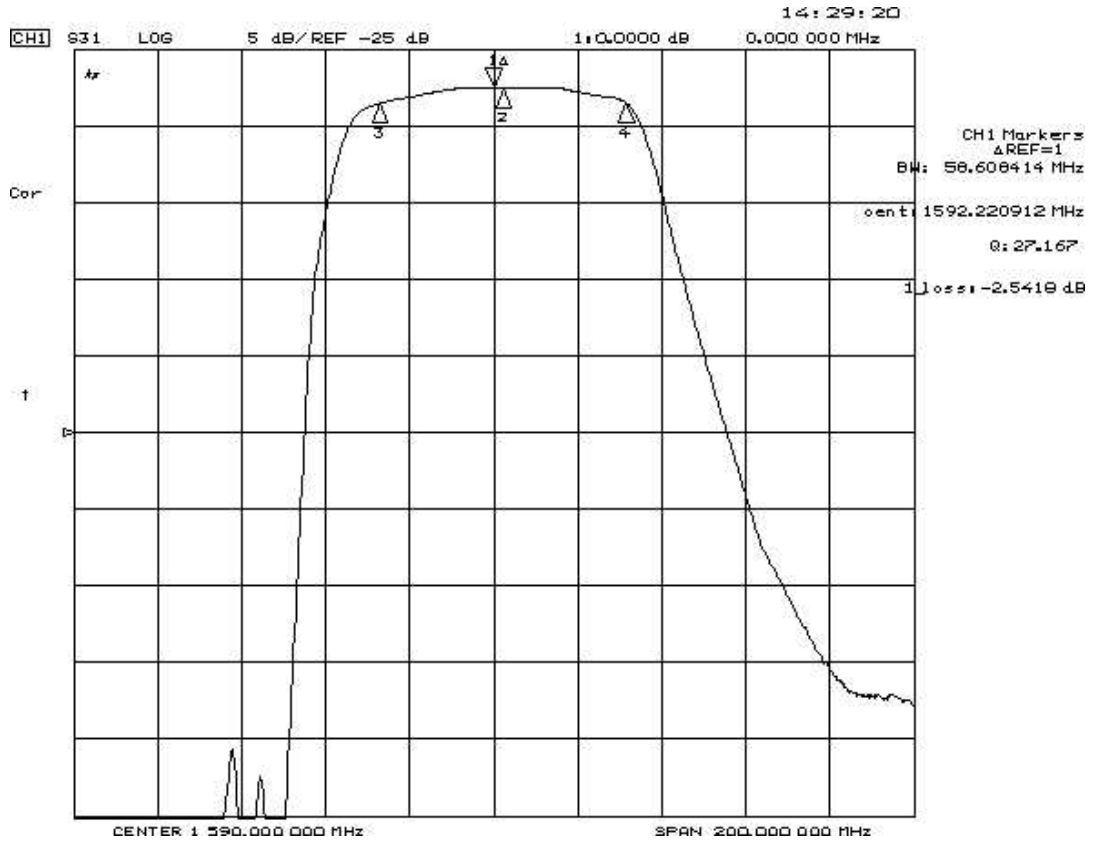

SAW Filter 1590MHz
Part No: MA09581

Model: TA0638A
REV. NO.: 1

Reflection Functions:

S11

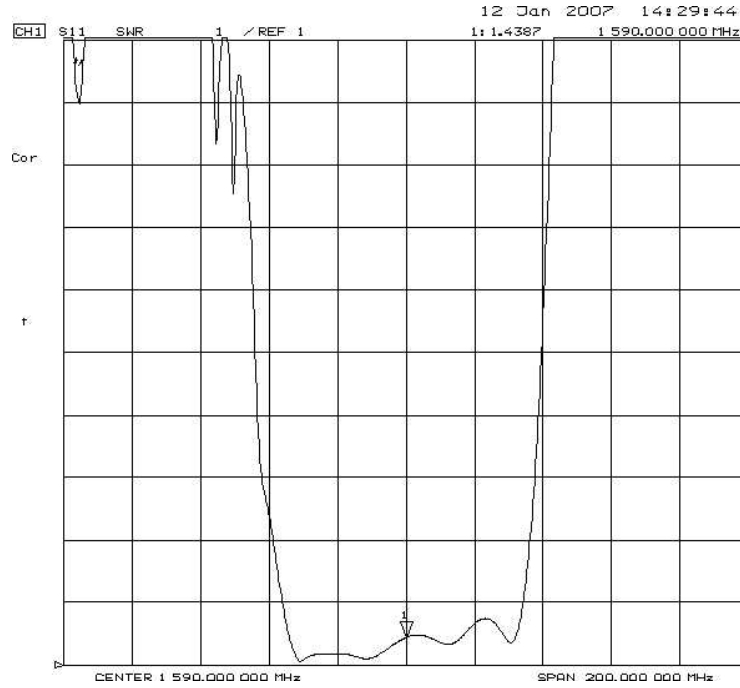

S22

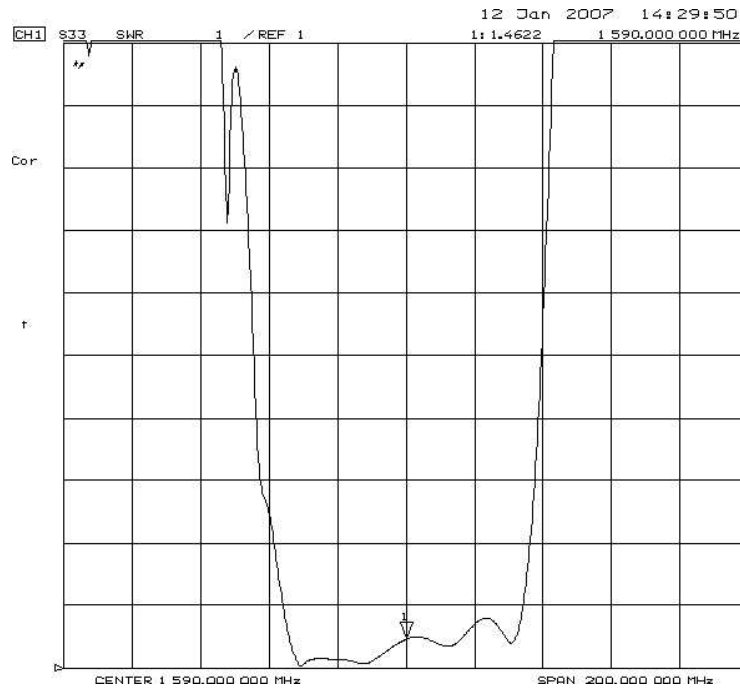

SAW Filter 1590MHz

Model: TA0638A

Part No: MA09581

REV. NO.: 1

H. RECOMMENDED REFLOW PROFILE :

